

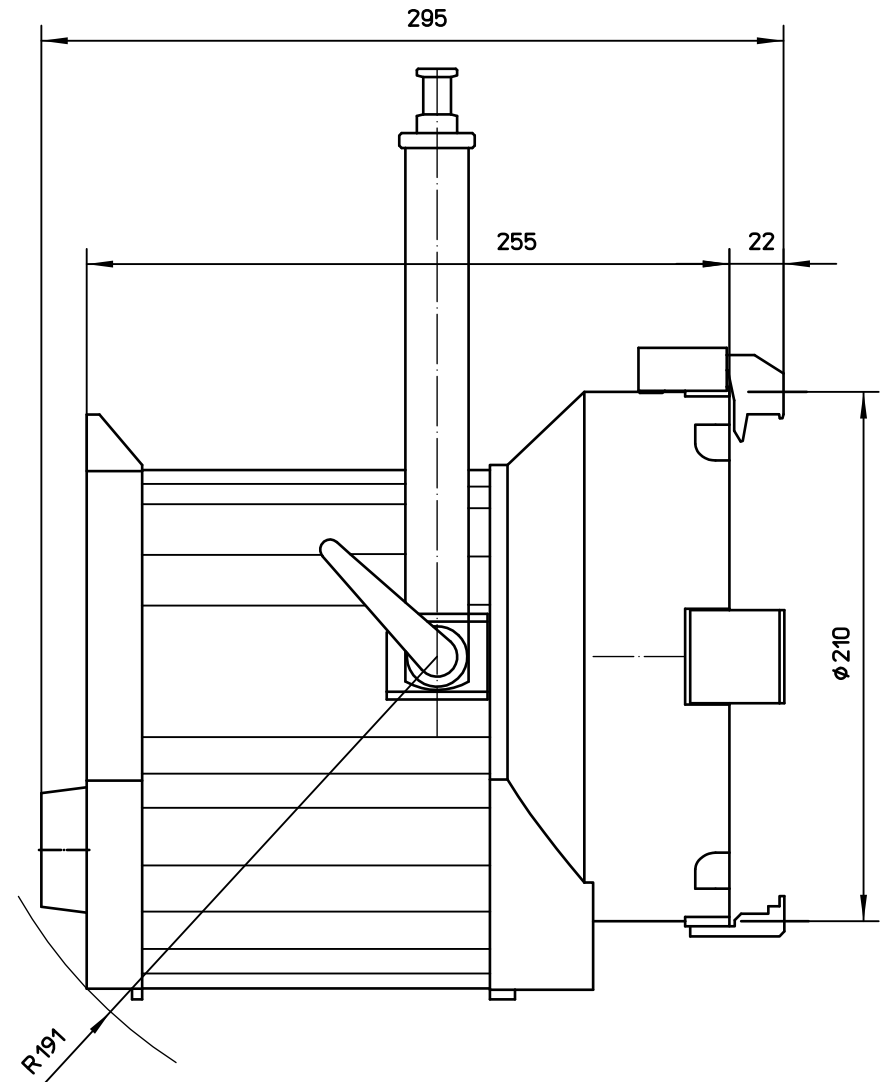

Schutzvermerk nach DIN34 beachten

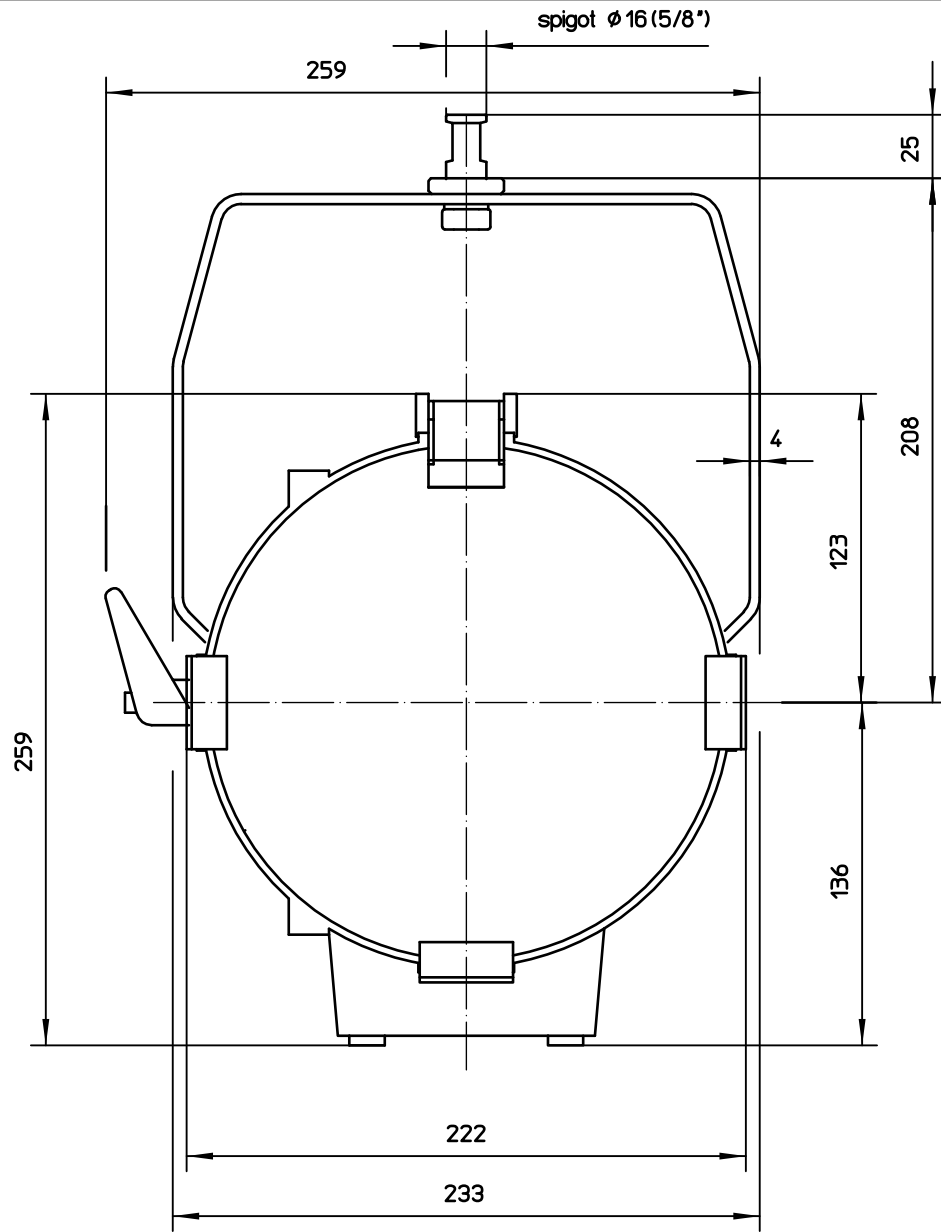

Scheinwerfertyp type of lamphead	ARRISUN 5 EVENT	Linsen lenses	Ø 200 mm Ø 7.9 "	Packmass packed size	475x380x320 mm 18.7x14.96x12.6 "	Gewicht net weight	4,5 kg 9,9 lbs	 Arnold & Richter Cine Technik Pulvermuehle D-83071 Stephanskirchen
Leuchtmittel lamp	HMI 575W/SE	Zubehoer accessories	Ø 212 mm Ø 8.3 "	Packvolumen packed volume	57,76 l 2.04 ft3	Dateiname file name	ase5_mb_02	
Lampensockel lamp base	G22	Fluegeltor barndoor	Ø 195 mm Ø 7.7 "	Packgewicht packed weight	6,1 kg 13.45 lbs	Version / Stand version / as at...	1.1/07.07.06	