

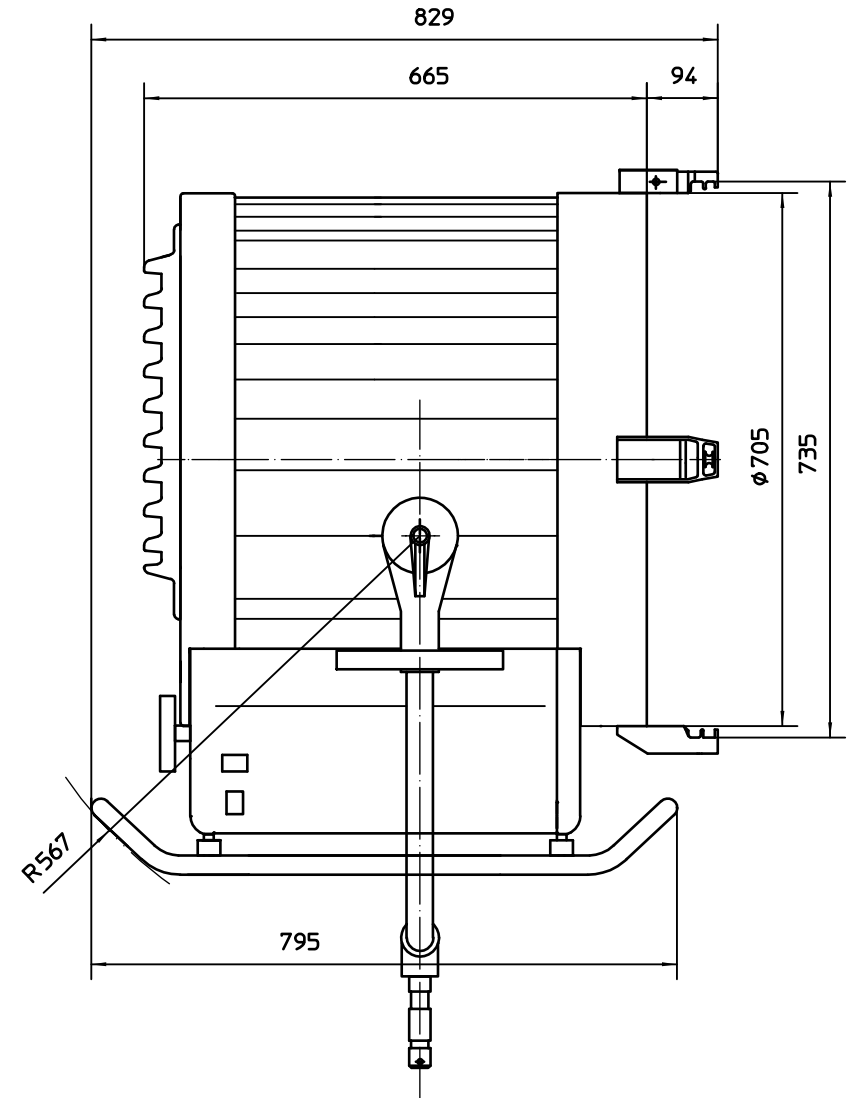

Schutzvermerk nach DIN34 beachten

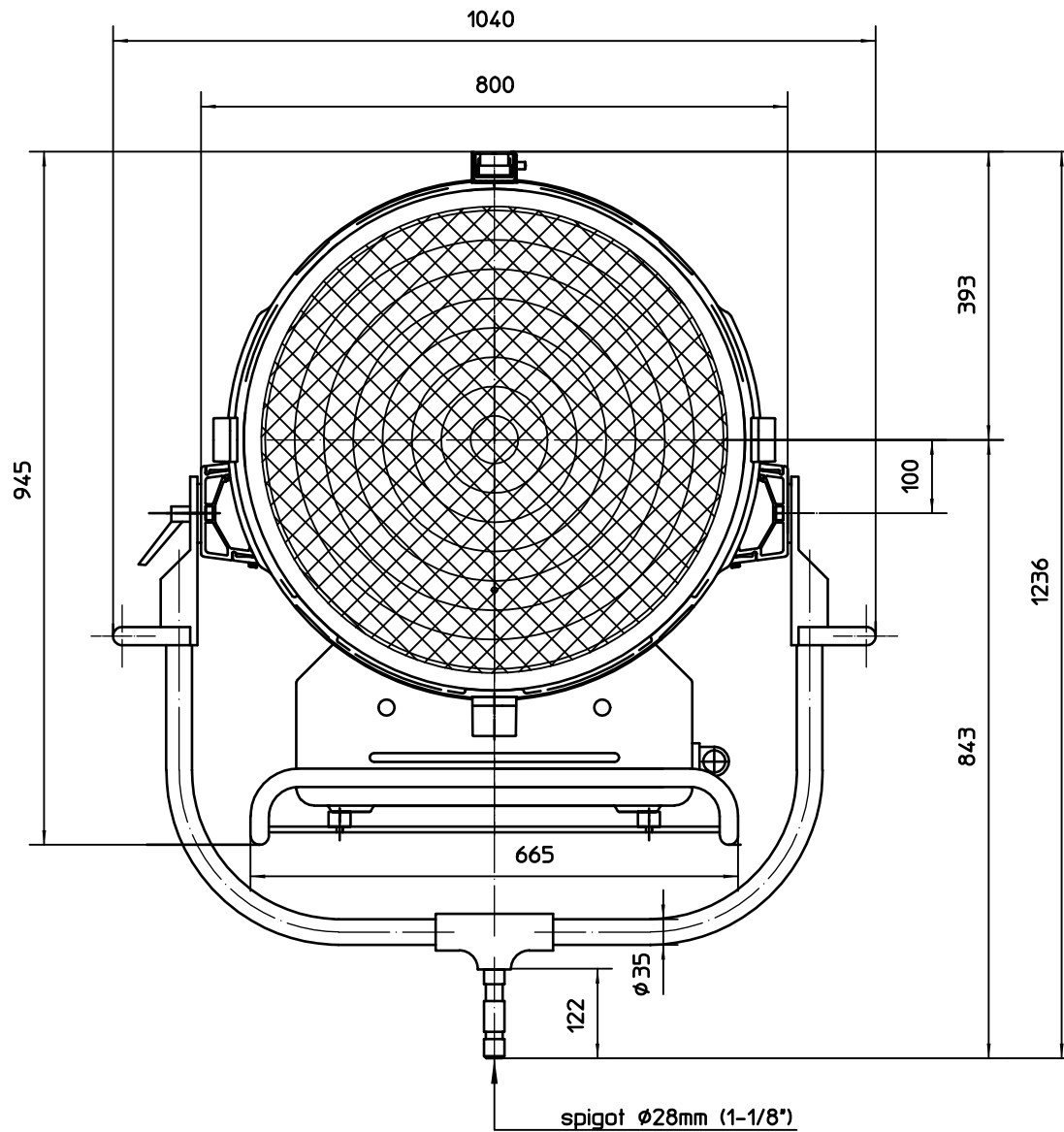

Scheinwerfertyp type of lamphead	Daylight 18kW/12kW +	Linsen lenses	Ø 625 mm Ø 24.6 "	Packmass packed size	1170x1050x1135 mm 46.06x41.34x44.69 "	Gewicht net weight	68.9 kg 151.9 lbs	 Arnold & Richter Cine Technik Pulvermuehle D-83071 Stephanskirchen
Leuchtmittel lamp	HMI 18000W/DE HMI 12000W/DE	Zubehoer accessories	Ø 740 mm Ø 29.1 "	Packvolumen packed volume	1394.35 l 49.241 ft3	Dateiname file name	dl_18_12+_mb_02	
Lampensockel lamp base	S30	Fluegeltor barndoor	Ø 740 mm Ø 29.1 "	Packgewicht packed weight	114 kg 251.32 lbs	Version / Stand version / as at...	1.1/07.07.06	